

DOUBLE - ENDED GRINDERS

GRYPHON - GR Series, Dust Extraction Mounted

The R.J.H Morrisflex GRYPHON Double-Ended Grinder has a highly respected reputation both in industry and education. The GRYPHON dust extraction model fully complies with UK COSHH regulations, the European Machinery Directive and also with the BS4163 "Health & Safety in Workshops of Schools and Similar Establishments" regulations. All R.J.H Morrisflex machines carry a 12 month warranty and are supplied with a comprehensive operating manual.

KEY FEATURES

- Integral dust extractor with a tray collector for easier and cleaner waste handling
- Adjustable, non-tip cast-iron work rest
- Spark arrestors
- Grinding wheels perfectly balanced for minimum noise and vibration
- Easy access for working on large work pieces
- Supplied with two 200 x 25mm grinding wheels

KEY SAFETY FEATURES

- No-volt overload push-button starter
- 110 volt control circuit
- Motor thermal overload protection
- Knee stop bar
- Fire retardant terylene needlefelt dustbag
- Heavy duty adjustable polycarbonate eye shields
- Full wheel guarding

OPTIONAL REFINEMENTS

- Flexible halogen floodlight with transformer
- Lockable triple pole isolator
- Lockable "E" stop
- Single phase unit
- Can be supplied with wire brushes instead of wheels
- Twist drill and side grinding attachments



Gryphon GR2003TE



Eye Shields and Adjustable Work Rest



Knee Stop Bar



Electric Controls

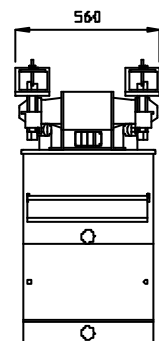

Front

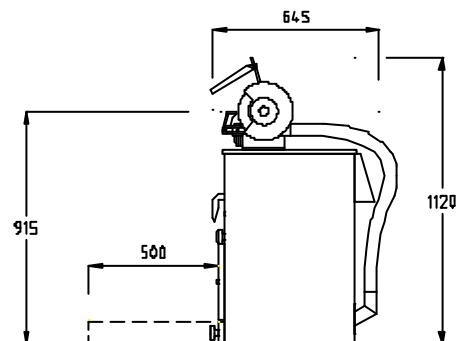

Side





Further information and full specifications from:

RJH MORRISFLEX LTD, Artillery Street, Heckmondwike, West Yorkshire, WF16 ONR, United Kingdom
 Tel: 01924 402490 International: (0044) 1924 402490 Fax: 01924 404647 International: (0044) 1924 404647
 Email us on sales@rjheng.co.uk, or visit us @ www.rjheng.co.uk

DOUBLE - ENDED GRINDERS

GRYPHON - GR Series, Bench and Pedestal Mounted

The RJH Morrisflex GRYPHON is also available as a bench or pedestal model, designed for use with centralised dust extraction systems. The pedestal and bench models incorporate the same safety features as the dust extractor model, and are available with the same optional refinements. The differences to the dust extraction mounted version are detailed in the table below:

| KEY: ● =included, ✕ =not available | DUST EXTRACTION | PEDESTAL | BENCH |
|---|-----------------|----------|-------|
| Dust Extractor | ● | ✕ | ✕ |
| Push-button Stop  | ● | ● | ● |
| Stop Bar  | ● | ✕ | ✕ |
| Foot Stop  | ✕ | ● | ✕ |
| 110V control system  | ● | ✕ | ✕ |



Gryphon, GR2003*P

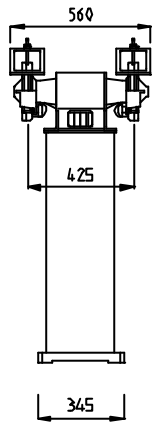

Front

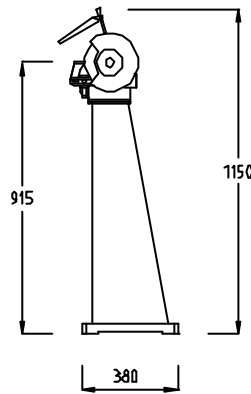

Side



Gryphon, GR2003*

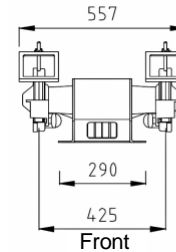

Front

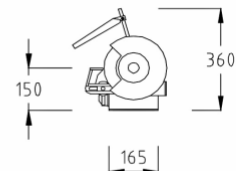

Side

SPECIFICATION - GRYPHON Double-Ended Grinders

| MODEL | DUST EXTRACTION | | PEDESTAL | | BENCH | |
|----------------------|------------------------------|----------|------------------------------|----------|------------------------------|----------|
| | GR2003TE | GR2003SE | GR2003TP | GR2003SP | GR2003T | GR2003S |
| Weight | 79 Kg | 79 Kg | 50 Kg | 50 Kg | 26 Kg | 26 Kg |
| Wheel Drive Motor | 0.85 Kw | 0.70 Kw | 0.85 Kw | 0.70 Kw | 0.85 Kw | 0.70 Kw |
| Electrical Supply | 400/3/50 | 230/1/50 | 400/3/50 | 230/1/50 | 400/3/50 | 230/1/50 |
| Wheel Speed | 2880 @ 50 Hz 3450 @ 60 Hz | | 2880 @ 50 Hz 3450 @ 60 Hz | | 2880 @ 50 Hz 3450 @ 60 Hz | |
| Dust Extractor Motor | 0.55 Kw | | N/A | | | |
| Grinding wheel Size | 200 mm x 25 mm x 20 mm | | | | | |

Further information and full specifications from:

RJH MORRISFLEX LTD, Artillery Street, Heckmondwike, West Yorkshire, WF16 ONR, United Kingdom
 Tel: 01924 402490 International: (0044) 1924 402490 Fax: 01924 404647 International: (0044) 1924 404647
 Email us on sales@rjheng.co.uk, or visit us @ www.rjheng.co.uk